

LED Emergency Pack - 100% BLF - EP3

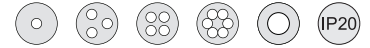

Full power in emergency mode, for constant current & constant voltage LEDs, 40W

Data sheet page 1

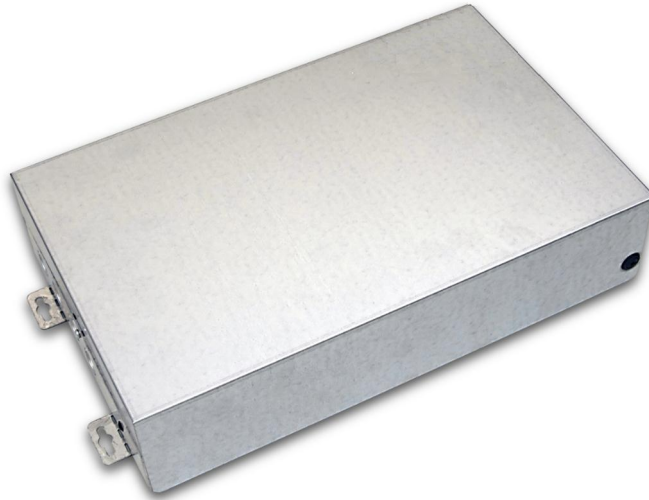

EP3 (MMA/LA/40)

A remote conversion kit designed to provide full output in emergency mode and will power all loads capable of accepting 230VDC, up to 40W. 3Hr emergency lighting conversion kits designed to suit a wide variety of LED types and circuits. It is suitable for both constant current and constant voltage LEDs.





Key Features

- Full output in emergency mode
- Conversion kit for mains voltage LED drivers
- Deep discharge protection
- Entire unit housed inside one enclosure
- High capacity VRLA batteries (integral)
- Max 40W load
- Supplied with 1m green charge healthy LED indicator and mounting collar

Specification

	EP3
Input Voltage	220-240 Volts AC 50/60Hz
Power Rating	6.0 Watts
Emergency Duration	3 Hours
Ballast Lumen Factor (BLF)	100% in Emergency Mode
Maximum Output	40 Watts
Battery Type	12 Volt Valve Regulated Lead-Acid
Capacity	17Ah
Charger	Constant Voltage
Recharge Time	24 Hours
Cut-Off Voltage	10.2 Volts
Ambient Temperature	0°C to + 25°C
IP Rating	IP20
Enclosure	Sheet Steel Hinged Enclosure
Dimensions	380mm x 242mm x 90mm
Battery Pack	Integral
Overall Weight	9.0KG

Quantitative Fittings per Emergency Pack

LED type	Example Fittings	Maximum amount of LEDs per Emergency Pack		
		350mA	500mA	700mA
1 LED cluster 	LD56, LD72	33	23	16
3 LED cluster 	LD52, LD74	11	7	-
4 LED cluster 	LD151, LD10238	8	5	4
6 LED cluster 	LD1210, LD1220	5	4	2
COB LED 	LD1080, LD1092	5	4	2

LED Emergency Pack - 100% BLF - EP3

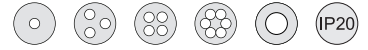

Full power in emergency mode, for constant current & constant voltage LEDs, 40W

Data sheet page 2

Installation Details - Typical Wiring Diagram

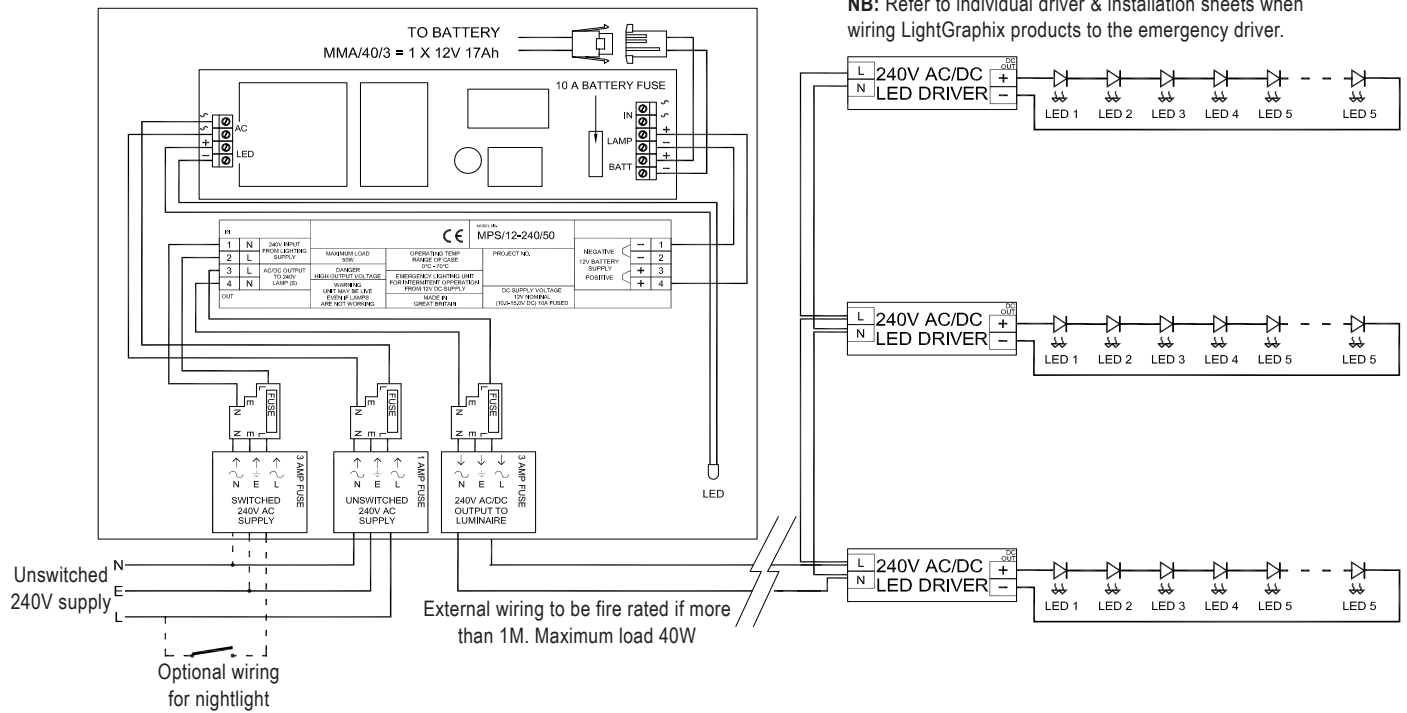

Fixing Options and Dimensions

Dimensions - Module (WxHxD)	380mm x 242mm x 90mm
Total Weight	9.0 Kg

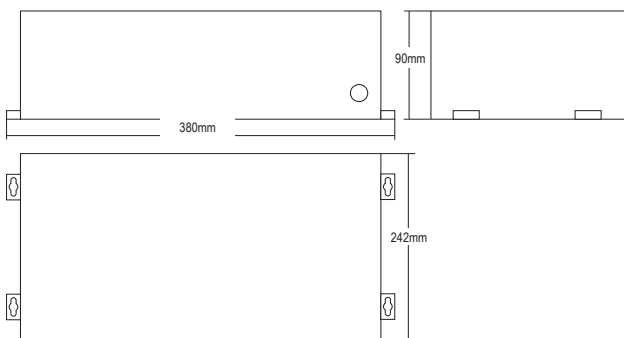

Order Codes

Emergency pack option	Order Code
EP3 (MMA/LA/40)	EP3 (MMA/LA/40)

LED Emergency Packs - EP4

Emergency pack for constant current LEDs

Data sheet page 3

EP4 (NLP/1/TP40)

3Hr emergency lighting conversion kits designed to suit a wide variety of LED types and circuits. They are designed to be installed by breaking into the low voltage connection between the mains LED driver and the LEDs and allows the LEDs to be operated as normal under mains healthy conditions and operated at reduced light output in an emergency. The emergency driver is designed to automatically adjust the LED output current to provide the best match between the battery and the load, providing maximum illumination whilst ensuring full battery duration.

The emergency pack will need a specified LED driver to run the LEDs when not in emergency mode.

EP4 - (NLP/1/TP40)

Emergency LED driver and batteries supplied in a single enclosure. Specified driver supplied and wired separately.

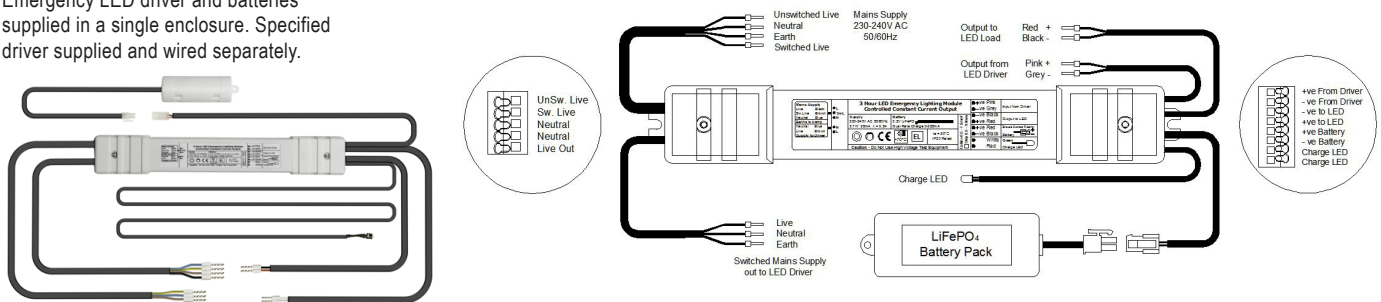

Ballast Lumen Factor

The Ballast Lumen Factor is the output of the LED in emergency mode, and is described as a percentage of the output in normal operation

Output Current (mA)			Number of fittings													
Example product			1	2	3	4	5	6	7	8	9	10	11	12	13	14
Single LED fittings		LD41, LD72	560mA	320mA	230mA	180mA	145mA	120mA	105mA	90mA	80mA	75mA	70mA	60mA	55mA	55mA
3 die LED fittings		LD52, LD75	230mA	120mA	80mA	60mA										
4 die LED fittings		LD151, LD153	180mA	90mA	60mA											
6 die LED fittings		LD1250, LD1210	120mA	60mA												
COB LED		LD1080, LD1092	120mA	60mA												

BLF can be worked out by dividing the current in emergency (see above) by the normal running current.
E.g. for 3 LEDs normally run at 700mA the BLF will be 250mA ÷ 700mA = 36%.

Luminaire Power	5W	7W	10W	14W
BLF	60%	43%	30%	21%

Specification

Supply Voltage	230-240 Volts AC 50/60 Hz
Power Rating	3.2 Watts
Power Factor	0.4
Duration	3 hours
Ambient Temp	0°C to + 50°C
Max case temperature	70°C
Max battery temperature	55°C
Terminal blocks	0.5-1.5mm ² Push Wire terminal
Battery fuse	Internal
Supply fuse	N/A
Battery pack	3.2V 3.6Ah LiFePO4 Cell
Charge current	0-250mA
Recharge period	24 hours

Dimensions

EP4

Dimensions - Module	231 x 34 x 23mm
Total weight	1.0Kg



Order Codes

Emergency pack option	Code
EP4 (NLP/1/TP40)	EP4